



SAGITTARIUS  
HTESS-10K/15K/20K 48B

# Product User Manual

## Hengtong Household Energy Storage System (Low Voltage Version)

Version Number: 20230801-V0

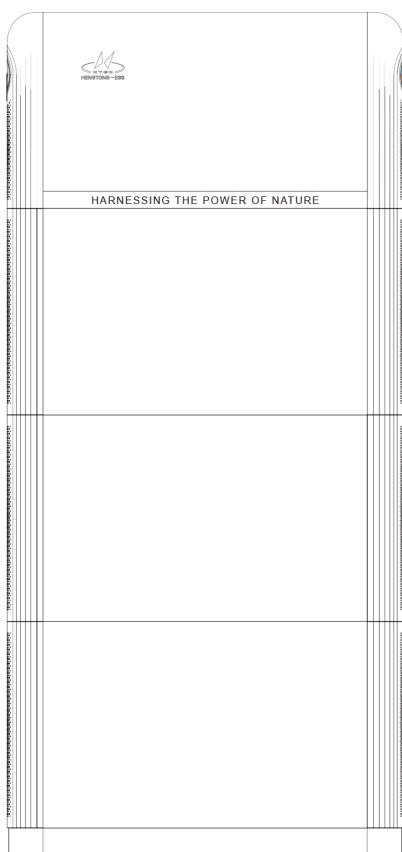

Cloud Platform



Data Download

## PREFACE

- The copyright of the information covered in this document belongs to Jiangsu Hengtong Energy Storage Technology Co., Ltd. Any part of this document may not be commercially reproduced in any form.
- This document primarily introduces the transportation and packaging, product information and parameters, installation wiring, configuration debugging, troubleshooting, and maintenance of the Hengtong Household Energy Storage System (Low Voltage Version). Before installing or using this product, please read this manual carefully to understand the product's safety information and familiarize yourself with its features and characteristics.
- Jiangsu Hengtong Energy Storage Technology Co., Ltd strictly complies with local laws and regulations.
- Specifications in this document are subject to change without prior notice. We have made every effort to ensure that this document is complete, accurate, and up-to-date. However, in some cases, improvements may be necessary, and no further notice will be given. The company is not responsible for any losses incurred due to this document, including but not limited to omissions, printing errors, arithmetic errors, or listed inaccuracies.

## VERSION HISTORY

The latest version in the revision history includes updates from all previous document versions.

20230801-V0    AUGUST 01, 2023 INITIAL RELEASE

## GENERAL INSTRUCTIONS

### Symbol Definitions

This manual aims to ensure the personal and property safety of users during the installation of this product and to enhance the optimal use of the product. Relevant information is outlined in this manual, and industry-standard symbols are used for emphasis. Please carefully read the following symbols used in this product for a better understanding and use of this manual.



**Danger**

Danger: Indicates that failure to avoid it may result in personal injury, severe accidents, or harm  
Indicates a high-risk level of injury



**Warning**

Warning: Indicates that failure to avoid it may result in personal injury, severe accidents, or harm  
Indicates a moderate-risk level of injury



**Caution**

Caution: Indicates that failure to avoid it may result in minor or moderate personal injury  
Indicates a low-risk level of injury

### ABBREVIATION DEFINITIONS

Full Name	Abbreviation
Flexible printed circuit	FPC
Battery management system	BMS
Battery management unit	BMU
Begin of life	BOL
Current connection between cells	Bus-bar
Controller area network	CAN
State Of Charge	SOC
Battery Module	BM
Power Conversion System	PCS
End of life	EOL
Open circuit voltage	OCV
Switch Gear	S/G

## TABLE OF CONTENTS

<b>01. Safety Instructions</b>	01	<b>05. Installation</b>	09
		5.1 Installation Precautions	09
<b>02. Overview</b>	02	5.2 Installation Tools	10
2.1 Introduction	02	5.3 Safety Protective Equipment	10
2.2 Energy Storage Capacity	02	5.4 Operational Safety	11
Explanation		Requirements	
2.3 Networking Applications	03	5.5 The Machine Installation	11
<b>03. Packaging For Shipping     And Storage</b>	03	Process	
3.1 Items In The Packaging Box	03	<b>06. Maintenance Guide</b>	19
3.2 Transportation Requirements	05	6.1 Maintenance Cautions	19
3.3 Storage Requirements	05	6.2 Periodic Maintenance	19
<b>04. Product Introduction</b>	05	6.3 Diagnosis of Common	20
4.1 Identity Definition	05	Abnormalities	
4.2 Icom Explanation	05	6.4 Battery Protection	21
4.3 Household Energy Storage	06	6.5 Accident Handling	21
System Appearance		<b>07. After-Sales Service</b>	22
4.4 Light Logic Explanation	06		
4.5 Buzzer Action Explanation	07		
4.6 Button Instructions	08		
4.7 Product Specifications	08		



# 1.SAFETY INSTRUCTIONS

## Danger

- Only professionals who are familiar with local laws, regulations, standards, and electrical systems, and have received specialized training and possess knowledge related to this product, are allowed to operate the battery system.
- Operations such as live installation, wiring, maintenance, and replacement of components are strictly prohibited. Contact between the power lines and conductors can generate arcs or sparks, leading to fires or personal injuries.
- This battery system is classified as a low-voltage system. Installation, usage, and operation of the battery system are strictly prohibited in adverse weather conditions such as thunderstorms, rain or snow, and wind speeds of seven or above.
- Translation: If any obvious defects, damages, or missing components are found in the electrical cabinet or battery box, please do not use them, and contact professional after-sales personnel.
- Do not place the battery near high temperatures, high-pressure, or heat-generating equipment. Battery damage may lead to electrolyte leakage. If electrolyte leakage occurs, do not touch the leaked electrolyte and evaporating gases. Take necessary precautions and immediately contact the after-sales service center for assistance.
- Without official authorization from the product, do not disassemble or modify any part of the battery box or electrical cabinet.
- In the event of a flood, do not use batteries that have been submerged in water. Please contact a local battery recycling service for proper disposal.
- In the event of a fire, turn off the power to the equipment if it can be done safely.

## Warning

- If inhaling leaked substances, evacuate from the contaminated area and seek medical assistance immediately.
- If in contact with eyes, rinse with clean water for at least 15 minutes/If in contact with skin, thoroughly wash the affected area with soap and water/In case of ingestion, induce vomiting immediately and seek medical assistance promptly.
- For battery replacement or addition, please contact the after-sales service center. Do not disassemble the mobile battery system without authorization.
- Approval from relevant authorities in the country is required before connecting to the grid.
- Prohibited activities include compiling or decompiling the device or engaging in other derivative works, as well as stealing the device's intellectual property.
- When installing grounding equipment, connect the wires first and disconnect the ground wire last when removing the equipment.
- Dispose of old batteries properly; do not treat them as general waste to avoid environmental pollution.
- Contact a battery recycling company for proper disposal, adhering to local laws and regulations.

## Caution

- Store and transport the battery system as required to ensure it remains undamaged during transportation and storage.
- Exercise caution and consider the weight when lifting the battery or electrical cabinet.
- Wear gloves when handling batteries during transport.
- Do not impact, pull, drag, or step on the equipment, and do not place unrelated items in any part of the battery module.
- Transportation must be carried out by trained professionals, and operations during the process must be documented.

- Ensure the equipment is placed securely and not tilted, as tilting may lead to equipment damage or personal injury.
- Make sure there are liquid carbon dioxide, Novac1230, or FM-200 fire extinguishers near the equipment.
- When extinguishing fires, use extinguishers with recommended materials; do not use water or ABC dry powder fire extinguishers. Firefighters should wear protective clothing and self-contained breathing apparatus.
- There is a risk of explosion when the ambient temperature exceeds 150°C.
- Use appropriate tools and protective measures when installing and maintaining heavy equipment to prevent cabinet scratches. If scratches occur, repair them promptly to prevent rust.
- Use specialized insulation tools for high-voltage operations.
- Cable usage in high-temperature environments may cause insulation aging and damage. The distance between cables and heating devices or the periphery of heat sources should be at least 30mm.
- Bundle cables of the same type together and keep cables of different types at least 30mm apart, avoiding intertwining or crossing.

## 2.OVERVIEW

### 2.1 Introduction

Jiangsu Hengtong Energy Storage Technology Co., Ltd is a wholly-owned subsidiary of Hengtong Group, established in 2019. The company is committed to providing customers with the service objectives of "more efficient energy," "cleaner energy," and "less carbon emissions." It focuses on renewable energy and energy storage business, dedicated to the utilization of green energy and efficient energy management. The company offers energy system solutions, including industrial and commercial energy storage, residential energy storage, multi-energy complementary microgrids, integrated solar and energy storage solutions, regional energy projects, and smart energy management. It aims to contribute to the sustainable development of global green energy.

### 2.2 Energy Storage Capacity Explanation

The energy storage system supports a maximum of 4 battery modules.

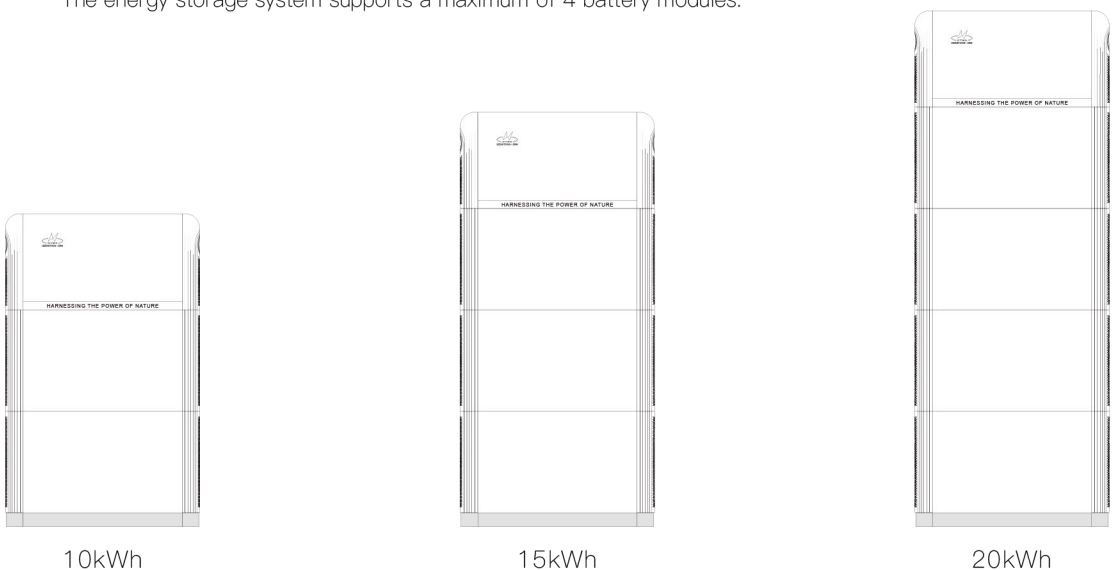

Note: The specific capacity is limited by the inverter power.

## 2.3 Networking Applications

The HTESS-10K/48B energy storage system is suitable for residential home photovoltaic power station systems, typically composed of string-connected photovoltaic arrays.

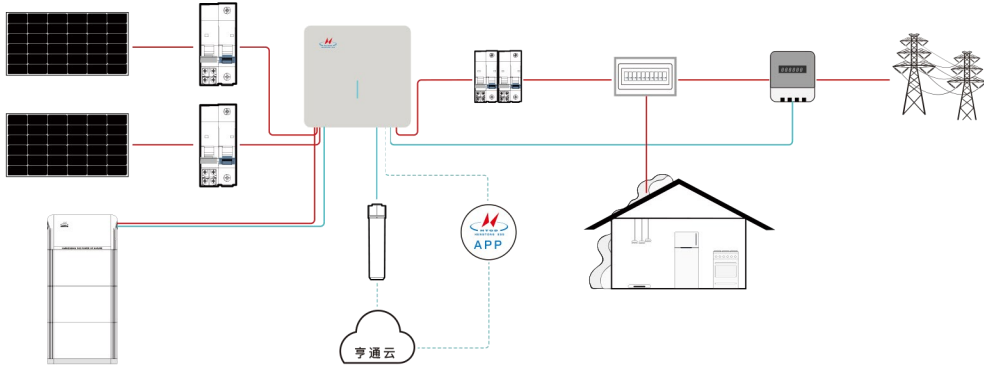

## 3.PACKAGING FOR SHIPPING AND STORAGE

### 3.1 Items in the Packaging Box

The battery system has undergone rigorous testing and inspection by our company. However, damage may still occur during transportation, so please inspect it carefully.

If you discover any transport damage or missing parts, please report it immediately to the shipping company and your local dealer. The packing list for the battery system is provided in Table 1, Table 2, and Table 3.











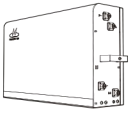
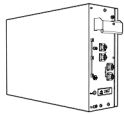

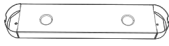



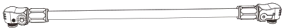

Packing List-10kWh					
					
Electrical boxX1	Battery boxX2	Electrical box decorative coverX2	Battery box decorative coverX4	BaseX1	Mounting bracketX4
					
Power line terminals (P-) X1	Power line terminals (P+) x1	Linking piecesx6	M5*10screwsX24	M6*60expansion screwsX6	
					
Power harness (B+) x1	Power harness (B-) X1		M6*12screwsx4	M4*10screwsx4	
					
Instruction manualX1	Certificate of conformityX1	Warranty cardX1	Grounding wirex1	Pass-through harnessX1	

Table 1











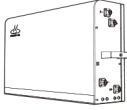









Packing List-15kWh					
					
Electrical boxX1	Battery boxX3	Electrical box decorative coverX2	Battery box decorative coverX6	BaseX1	Mounting bracketX6
					
Power line terminals (P-) X1	Power line terminals (P+) x1	Linking piecesx8	M5*10screwsX32	M6*60expansion screwsX8	
					
Power harness (B+) x2	Power harness (B-) X2	M6*12screwsx8	M4*10screwsx10		
					
Instruction manualX1	Certificate of conformityX1	Warranty cardX1	Grounding wirex3	Pass-through harnessX2	

Table 2











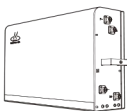
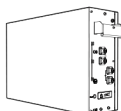







Packing List-20kWh					
					
Electrical boxX1	Battery boxX4	Electrical box decorative coverX2	Battery box decorative coverX8	BaseX1	Mounting bracketX8
					
Power line terminals (P-) X2	Power line terminals (P+) x2	Linking piecesx10	M5*10screwsX40	M6*60expansion screwsX10	
					
Power harness (B+) x3	Power harness (B-) X3	M6*12screwsx8	M4*10screwsx10		
					
Instruction manualX1	Certificate of conformityX1	Warranty cardX1	Grounding wirex4	Pass-through harnessX3	

Table 3

### 3.2 Transport Requirements

- a. During transportation, it should be strictly placed according to the direction indicated on the packaging box to avoid damage from strong vibrations, shocks, and heavy pressure during transportation.
- b. During long-distance transportation, it is not allowed to be loaded on open vehicles or cabins. Mixing with flammable and explosive items is not permitted.
- c. During handling, it should be handled with care and strictly follow the warning signs on the packaging box.
- d. It should not be stored outdoors during mid-transit, and exposure to rain, snow, or other liquid substances, prolonged exposure to sunlight, and mechanical damage should be avoided during transportation.

### 3.3 Storage Requirements













If the equipment is not immediately installed for use, please ensure that the storage environment meets the following conditions:

- a. The equipment should be packaged in the packaging box, and the packaging box should be sealed after placing a desiccant inside.
- b. If the equipment is not installed within 3 days after unpacking, it is recommended to store the equipment in the packaging box.
- c. Storage SOC: 25%~60% SOC, a charge and discharge cycle is required every 3 months of storage.
- d. Storage temperature range: Stored for no more than 3 months at conditions of -20°C~45°C; stored for no more than 1 year at conditions of 0°C~35°C.
- e. Humidity range: 0~95% without condensation. Installation is not allowed if there is moisture or condensation at the battery interface.
- f. The equipment should be stored in a cool place, avoiding direct sunlight. It should be protected from rain and stored away from flammable, explosive, and corrosive materials.

## 4. PRODUCT DESCRIPTION

This document primarily introduces the product overview, application scenarios, installation, debugging, maintenance, and technical specifications of the High Voltage Series Energy Storage Battery System (hereinafter referred to as the "Battery System").

### 4.1 Symbol Definitions

	After power-off, there is a delay in the discharge of components. Please wait for 5 minutes until the device is completely discharged.		
	High surface temperature		Prohibit short-circuiting the battery
	Caution, risk of electric shock		do not disconnect or dismantle it by non-professionals.
	be cautious about safety		Install the product in a place inaccessible to children.
	beware of fire hazards		Recyclable
	Before installation and use, please read the instruction manual carefully.		Do not dispose of this product with household waste.
	prohibit placing near flammable materials		CE Certification

### 4.2 ICOM Description

P- / External negative interface    P+ / External positive interface    B- / Battery negative interface    B+ / Battery positive interface    ON    OFF

RS232 / Link Port 1    / RS232 Communication Interface    RS485/CAN / 485 Communication Interface    Link Port 2 / Parallel 2    Reset / Reboot

### 4.3 Household Energy Storage System Appearance

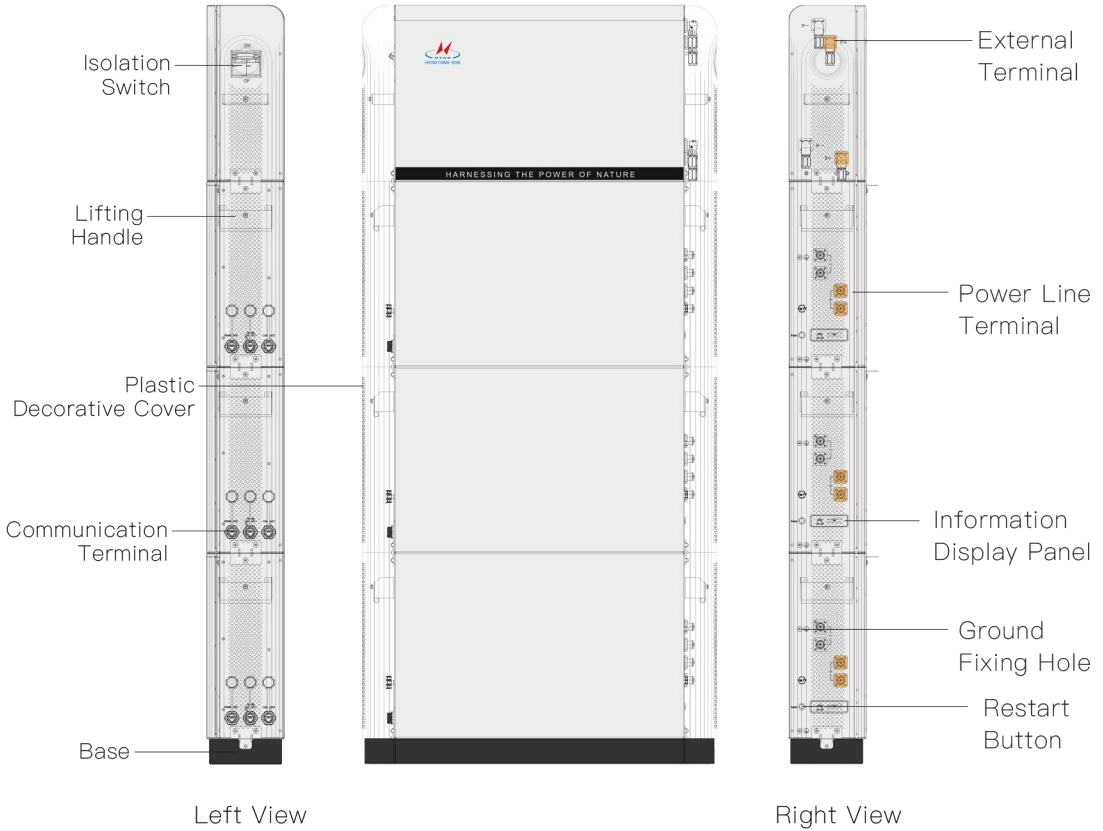

### 4.4 Light Logic Explanation

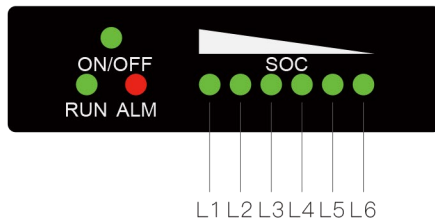

Flashing Mode	On	Off
Flashing 1	0.25S	3.75S
Flashing 2	0.5S	0.5S
Flashing 3	0.5S	1.5S

Table 1 LED Flashing Instructions

STATUS	NORMAL/ ALARM/ PROTECTION	ON/ OFF	RUN	ALM	BATTERY LEVEL DISPLAY LED						EXPLANATION	
		●	●	●	●	●	●	●	●	●		
Power Off	Sleep	OFF	OFF	OFF	OFF	OFF	OFF	OFF	OFF	OFF	OFF	All Off
Standby	Normal	ON	Flashing 1	OFF	According to the power prompt						Standby	
	Alarm	ON	Flashing 1	Flashing 3							Module Low Voltage	
Charging	Normal	ON	ON	OFF	According to the power prompt (The highest power indicator LED flashes 2)						The highest battery level LED flashes (2 times). ALM does not blink during overcharge warning.	
	Alarm	ON	ON	Flashing 3								
	Overcharge Protection	ON	ON	OFF	ON	ON	ON	ON	ON	ON	ON	If there is no mains power, the indicator light turns to standby state.
	Temperature, Overcurrent, Failure Protection	ON	OFF	ON	OFF	OFF	OFF	OFF	OFF	OFF	OFF	Stop Charging
Discharging	Normal	ON	Flashing 3	OFF	According to the power prompt							
	Alarm	ON	Flashing 3	Flashing 3								
	Undervoltage Protection	ON	OFF	OFF	OFF	OFF	OFF	OFF	OFF	OFF	OFF	Stop Discharging
	Temperature, Overcurrent, Short Circuit, Reverse Connection, Failure Protection	ON	OFF	ON	OFF	OFF	OFF	OFF	OFF	OFF	OFF	Stop Discharging
Malfunction		OFF	OFF	ON	OFF	OFF	OFF	OFF	OFF	OFF	OFF	Stop Charging, Discharging

Table2 LED Operational Status Indicator

STATUS		CHARGING						DISCHARGING					
Capacity Indicator Light		L6	L5	L4	L3	L2	L1	L6	L5	L4	L3	L2	L1
Power (%)	0–16.6%	OFF	OFF	OFF	OFF	OFF	Flashing2	OFF	OFF	OFF	OFF	OFF	ON
	16.6–33.2%	OFF	OFF	OFF	OFF	Flashing2	ON	OFF	OFF	OFF	OFF	ON	ON
	33.2–49.8%	OFF	OFF	OFF	Flashing2	ON	ON	OFF	OFF	OFF	ON	ON	ON
	49.8–66.4%	OFF	OFF	Flashing2	ON	ON	ON	OFF	OFF	ON	ON	ON	ON
	66.4–83.0%	OFF	Flashing2	ON	ON	ON	ON	OFF	ON	ON	ON	ON	ON
	83.0–100%	Flashing2	ON	ON	ON	ON	ON	ON	ON	ON	ON	ON	ON
Operation Indicator Light ●		ON						Flashing (flashing3)					

Table3 LED Capacity Indicator Explanation

Note: LED indicator alarm can be enabled or disabled through the upper computer. It is enabled by default when leaving the factory

### 4.5 Buzzer Action Explanation

- When there is a malfunction, it beeps for 0.25 seconds every 1 second.
- During protection, it beeps for 0.25 seconds every 2 seconds (except for overvoltage protection).
- During an alarm, it beeps for 0.25 seconds every 3 seconds (except for overvoltage alarm).
- The buzzer function can be enabled or disabled through the upper computer and is disabled by default when leaving the factory.



## 4.6 Button Instructions

When the BMS is in a dormant state, press and hold the button (36 seconds), then release it. The protection board is activated, and the LED indicator lights up sequentially starting from "RUN" for 0.5 seconds. When the BMS is in an active state, press and hold the button (36 seconds), then release it. The protection board goes into dormancy, and the LED indicator lights up sequentially starting from the lowest battery level light for 0.5 seconds. When the BMS is in an active state, press and hold the button (6~10 seconds), then release it. The protection board is reset, and all LED lights light up simultaneously for 1.5 seconds. After the BMS is reset, it still retains the parameters and functions set through the upper computer. If you need to restore to the initial parameters, you can achieve it through the upper computer's "Restore Defaults," but relevant operation records and stored data remain unchanged (such as battery level, cycle count, protection records, etc.).

## 4.7 Product Specifications

- 1.All data for the new battery are measured at a 100% depth of discharge (DoD), at +25°C, and at a charge/discharge rate of 0.2C; the available power may vary depending on the inverter used.
- 2.Rated charge/discharge current and power are influenced by temperature and SOC status.
- 3.The inverter on the off-grid side can provide a continuous output of 4600VA or a short-term output of 6900VA (not exceeding 10 seconds) to the load. The inverter also has a self-protection mechanism for derating in high-temperature environments (45°C~50°C).

PRODUCT PERFORMANCE	NUMERICAL VALUES		
Product model	HTESS-10K 48B	HTESS-15K 48B	HTESS-20K 48B
Rated voltage	51.2V		
Voltage range	44.8V-57.6V		
Rated capacity	200Ah @0.2C,25°C	300Ah @0.2C,25°C	400Ah @0.2C,25°C
Rated energy	10.24kWh @0.2C,25°C	15.36kWh @0.2C,25°C	20.48kWh @0.2C,25°C
Charge/discharge current	Standard20A @25°C, MAX100A @25°C(single unit)		
Communication method	CAN/RS485		
Expansion capability	4parallel		
Self-discharge	≤3%/M		
Protection functions	Overvoltage & undervoltage protection, overcurrent protection, short-circuit protection, over-temperature protection, under-temperature protection, etc.		
Protection level	IP54		
Cooling method	Natural cooling		
Cycle life	≥6000 cycles 80%DOD,@25°C		
Dimensions(w*h*d)	700*1125*152mm	700*1490*152mm	700*1855*152mm
weight	106kg	153kg	200kg
Operating temperature	Charaging: 0~ +60°C, Discharaging: -20~ +60°C		
Altitude	0~4000m(Derating for altitudes exceeding 2000 meters.)		



## 5. INSTALLATION

### 5.1 Installation Precautions

The energy storage battery system is a low-voltage energy storage device, and improper operation or usage by non-professionals may lead to serious consequences such as electric shock, combustion, and explosion of the battery system.

The installation and maintenance of the battery cabinet must be performed by professional technicians, and strict compliance with relevant safety regulations is required during use. Non-professionals are strictly prohibited from installing, repairing, and using the battery cabinet beyond its specified scope.

01. When installing the battery cabinet, check in advance whether the connection box, main control box, and related circuits are unobstructed, including the good contact of each connection point, to avoid introducing open or short circuit faults.

02. When installing the battery cabinet, ensure that the grounding equipment is effective.

03. When used, all poles must be connected with a certified overcurrent protection device.

04. Battery system installation requirements:

- The battery system should be installed on a ground with sufficient bearing capacity and flatness. If the ground lacks adequate support and flatness, it needs to be ensured through other means (such as foundation construction, adding load-bearing plates, etc.).
- The battery system should be installed on a wall with sufficient bearing capacity and flatness. If the wall lacks adequate support and flatness, it needs to be ensured through other means (such as building a cement wall, brick wall, etc.).
- The battery system needs to be installed against the wall (with a reserved 50mm assembly space).
- Do not place any items above the control cabinet.
- Do not place the system in areas with corrosive gases or liquids.
- Do not place flammable, explosive, or corrosive items around the equipment.
- Avoid installing in environments near high-temperature heat sources or low-temperature cold sources (ideal environment:  $-20\sim 40^{\circ}\text{C}$ ).
- Avoid placing it in areas exposed to direct sunlight, rain, or humidity.

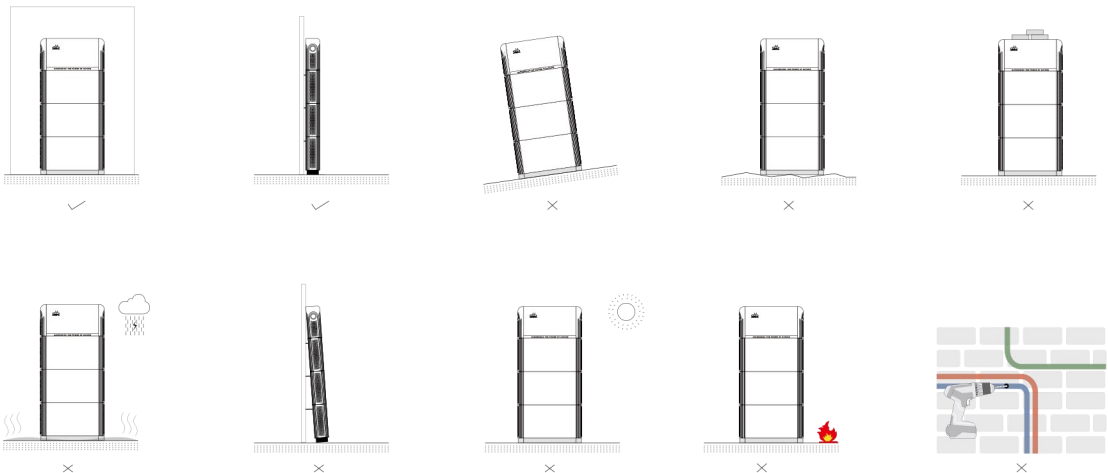





- Avoid installing in environments with strong interference.
- Avoid installing in areas prone to water accumulation.
- Do not install in areas accessible to children.

## 5.2 Tools To Prepare

			
Cross-head screwdriver	Socket wrench	Heat gun	Electric drill
			
Allen wrench	Utility knife	Marker pen	Spirit level
			
Heat shrink tubing	Mobile phone OR other internet-connected device	Vacuum cleaner	Multimeter

## 5.3 Safety Protective Equipment

			
Anti-static gloves	Eye shield	Dust mask	Safety shoes

## 5.4 Operational Safety Requirements

For the installation of the system to be safe and effective, installation personnel must be familiar with the content of this document and all warnings, and they must undergo professional training and qualification before taking up their positions.

- (1) This product is a low-voltage device. When operating and maintaining this product, please take personal protective measures and follow the operation regulations specified in the high-voltage standards. If direct handling of the battery is necessary, wear insulated rubber gloves.
- (2) For the safety of children, please place it out of reach of children.
- (3) When touching the battery system, please avoid contact with exposed metal parts.
- (4) To prevent static electricity buildup, maintenance personnel should discharge static electricity from their bodies before operating the battery.
- (5) Do not place tools or metal parts on top of the control cabinet.
- (6) At all times, do not touch all terminals with hands or other metal objects to prevent electric shock or short circuit.
- (7) Do not step on or sit on the battery system.
- (8) Do not directly short-circuit the positive and negative terminals of the battery; otherwise, it may cause battery leakage, heating, and rupture.
- (9) It is strictly prohibited to alter the battery without authorization; for safety reasons, a protection system is installed in the battery. If the protection system is damaged, it may result in a loss of control over charging and discharging, and the current during charging or discharging may exceed the set limits, leading to battery leakage, heating, and rupture.
- (10) It is strictly prohibited to cover the battery system during charging and discharging processes. Otherwise, accumulated heat may result, causing a decline in battery performance and liquid leakage.

## 5.5 The Machine Installation Process

### 5.5.1 Unboxing

- ① Take out the product one by one, verify and read the instruction manual, and check the products.

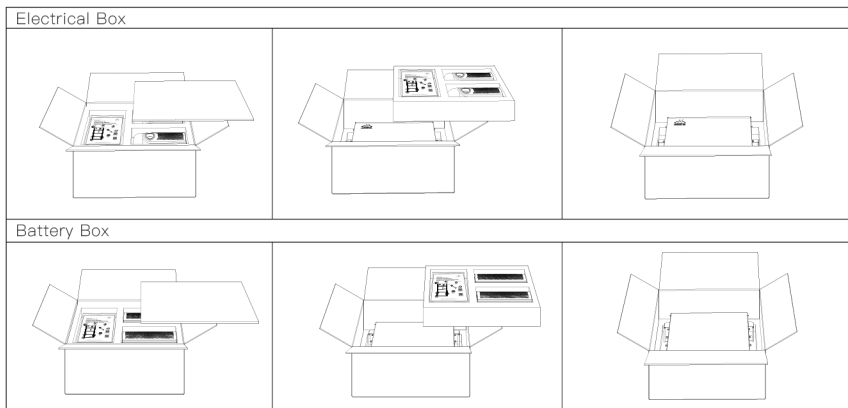

### 5.5.1 Installation Fixing Hole Diagram

**⚠ Danger** Installation Stacking Order Before installation, ensure that the circuit breaker in the electrical box is in the OFF position.

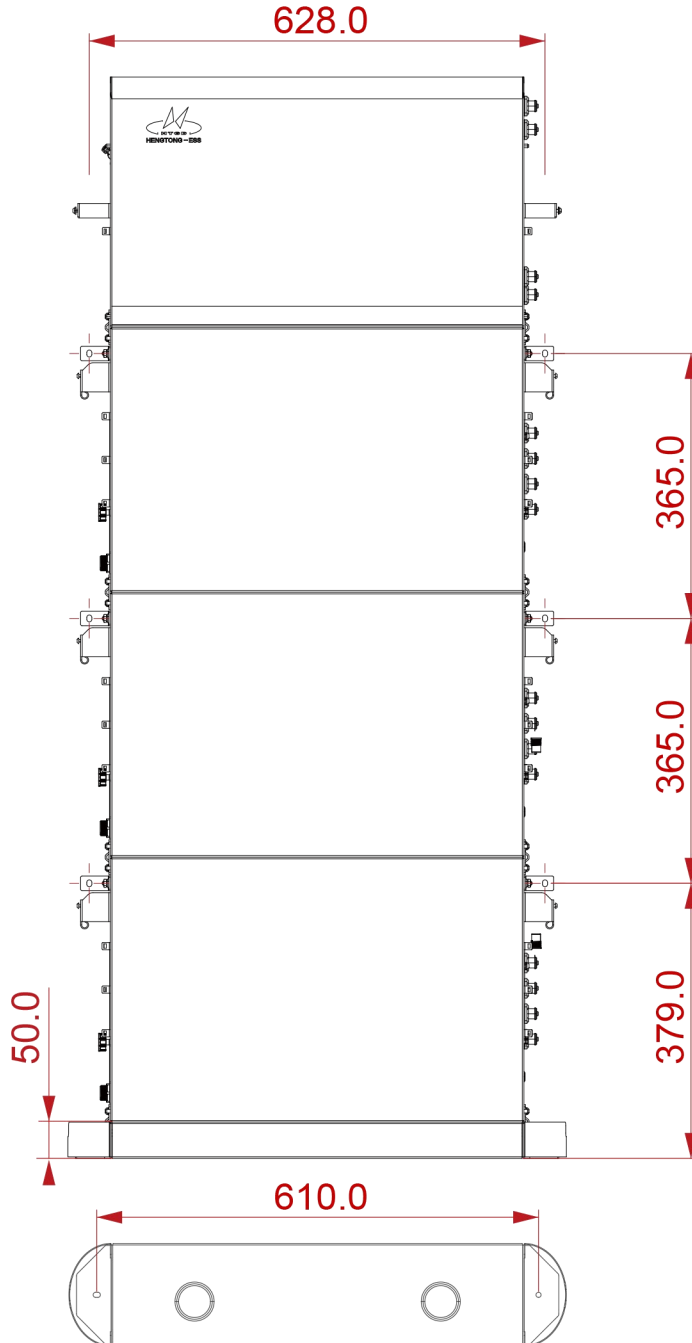

## 5.5.2 Battery System Installation

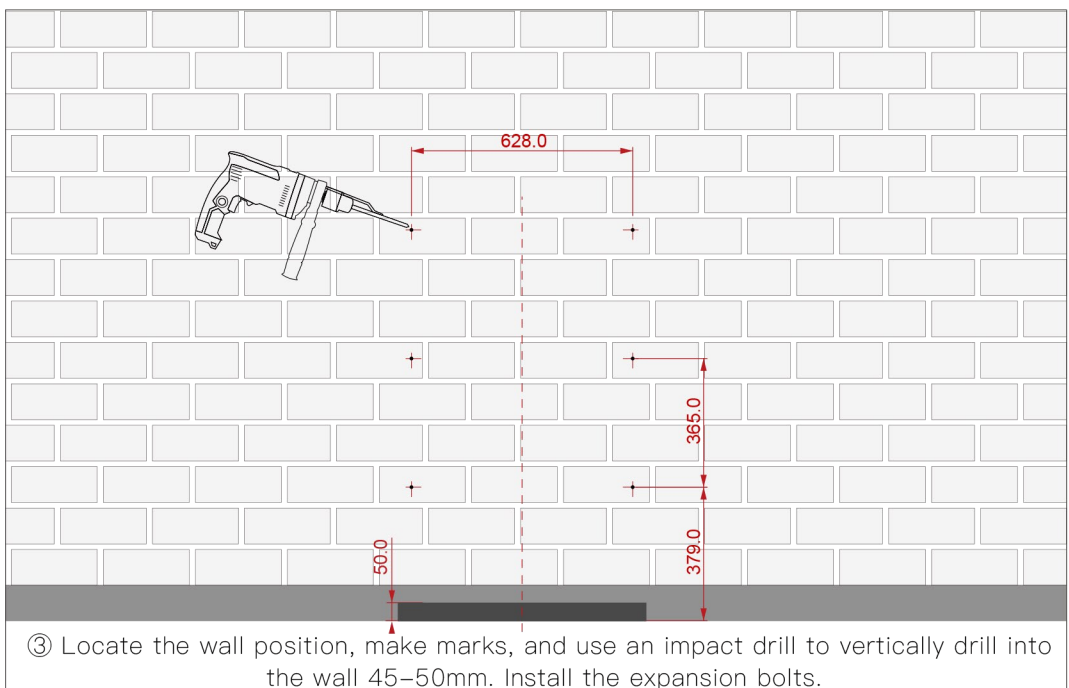
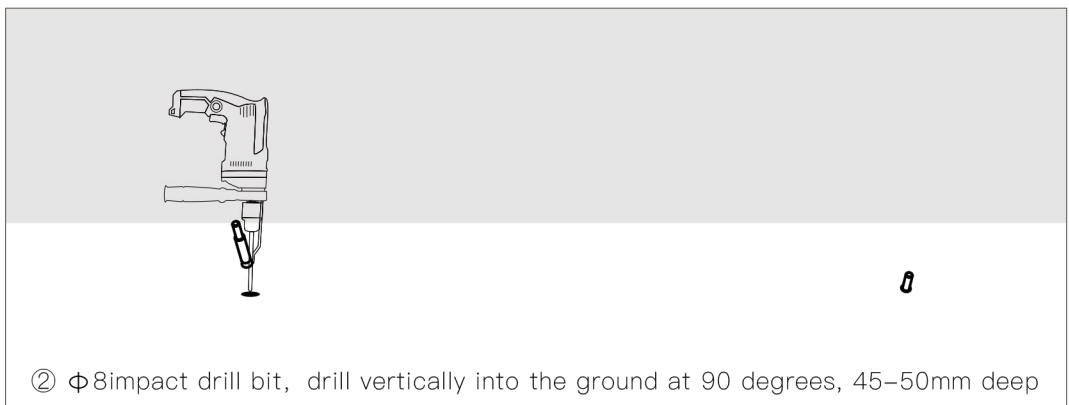
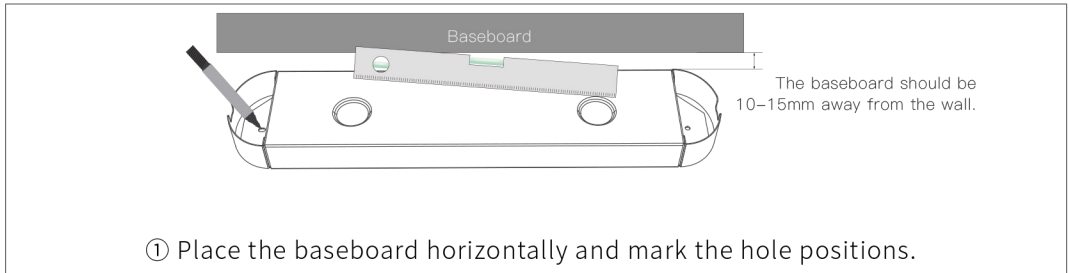

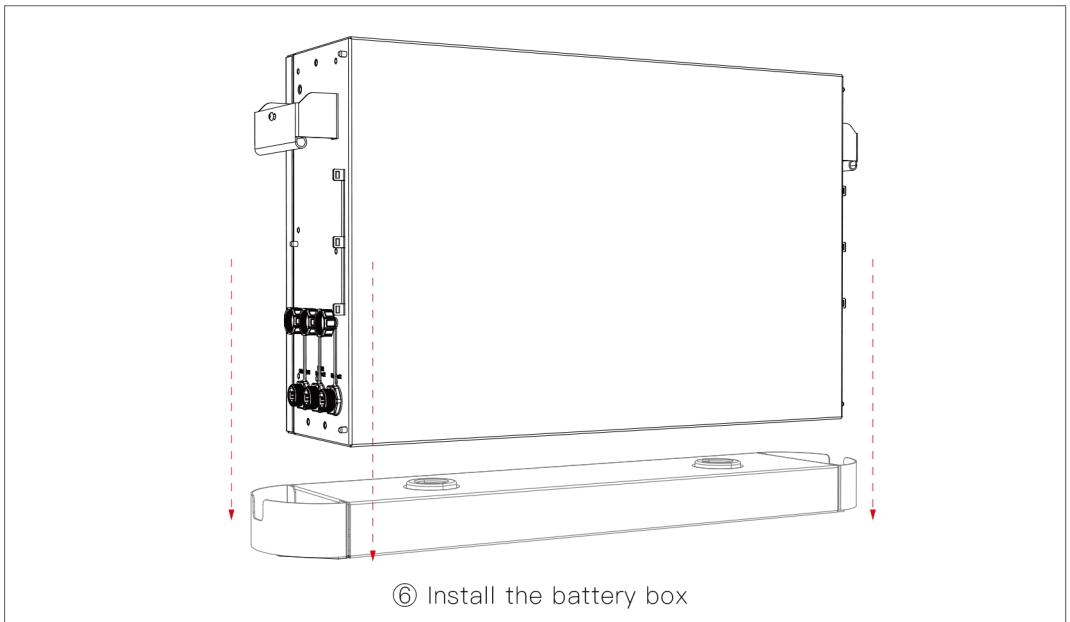
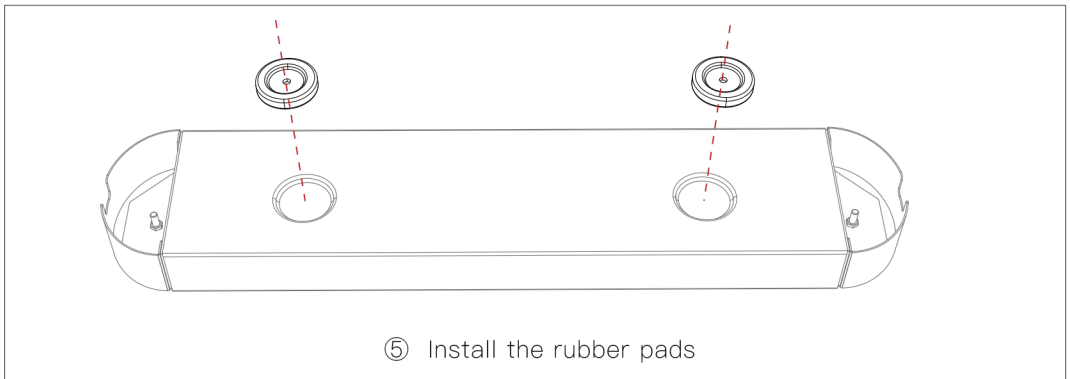
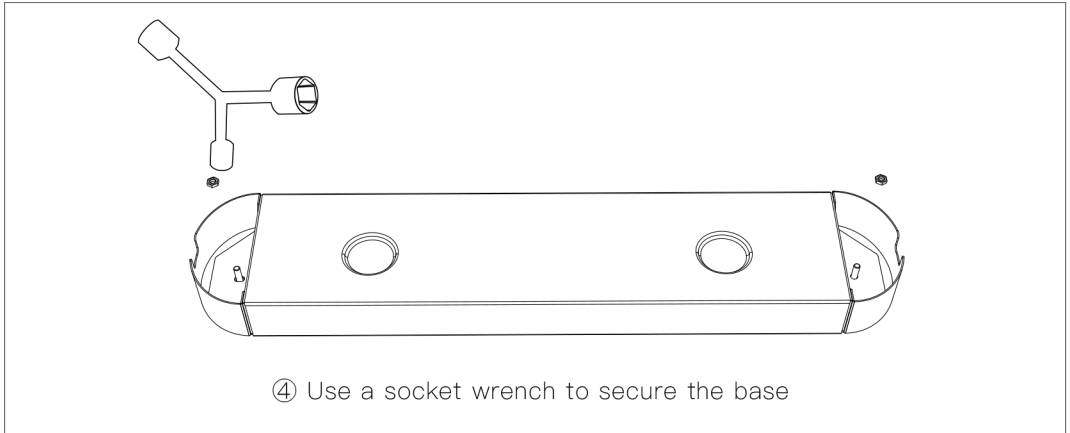

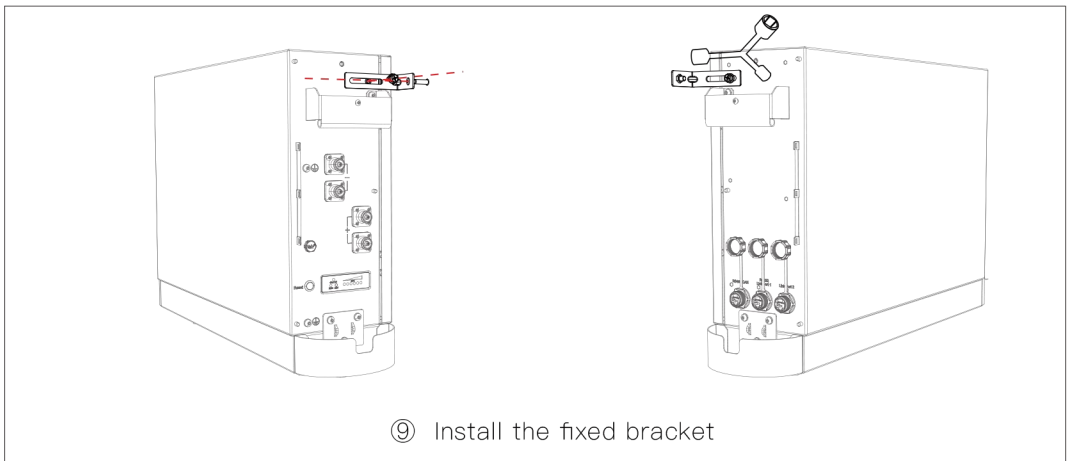
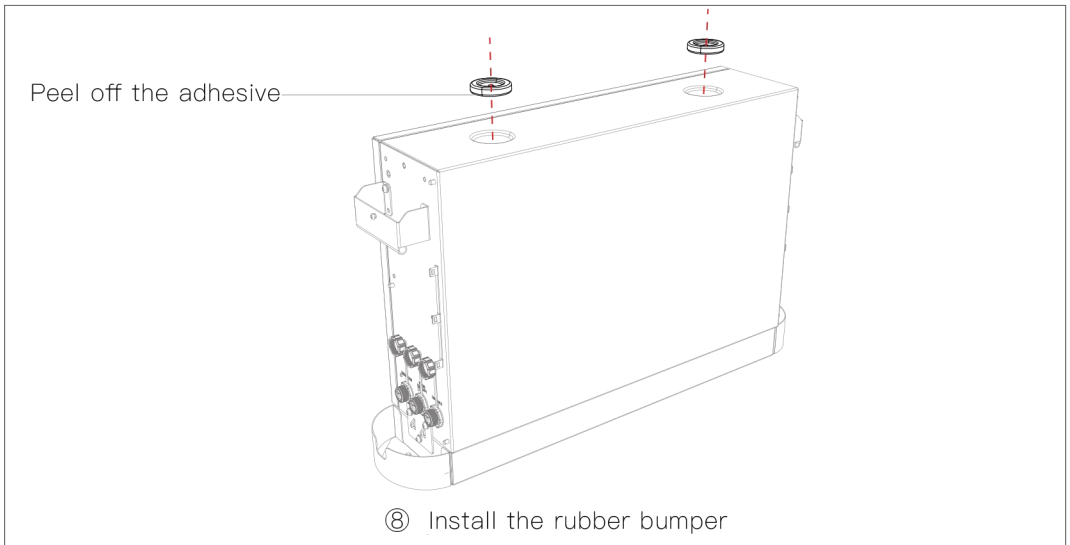
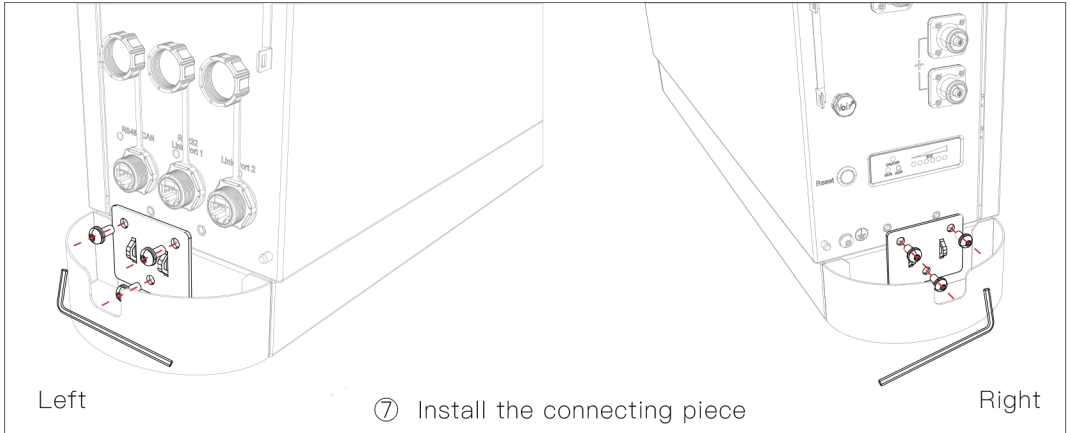

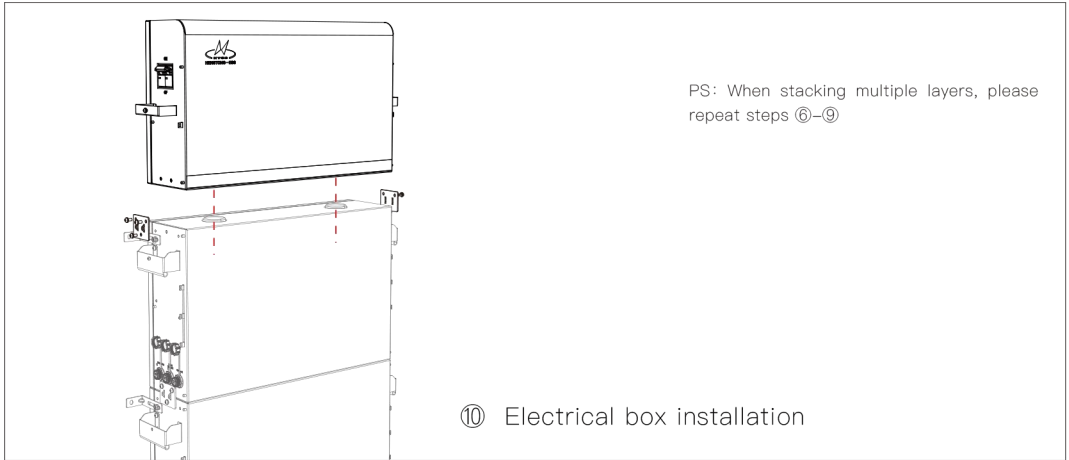

### 5.5.3 Electrical Component Installation

#### 5.5.3.1 Wiring Harness Assembly

#### Caution

Different versions come with slight variations in the provided connecting cables. Some connecting cables are pre-assembled and do not require on-site custom fitting; they can be used directly.

Please prepare a protective ground wire with a conductor cross-sectional area of 6 square millimeters. The wire should comply with outdoor usage standards, and the pull-out force after crimping should be greater than 400N.

#### Power cord assembly

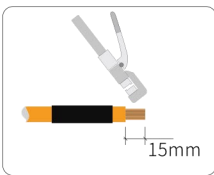

1  
Strip a certain length of conductor and insert it into the heat shrink tube.

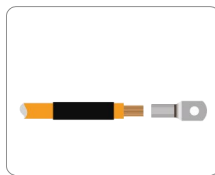

2  
Insert terminal block

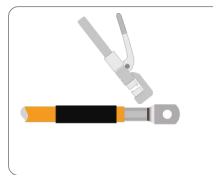

3  
Use crimping pliers to crimp the terminal tightly.

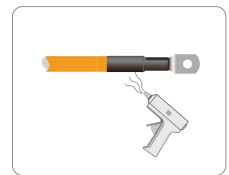

4  
Use a hot air gun to heat the heat-shrink tube.

#### Communication line assembly

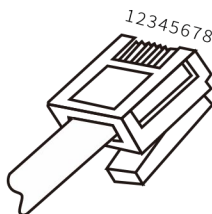
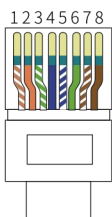

Parallel/PCS Communication Interface

Pins	Definition Explanation
2/7	RS485_A
1/3/6	RS485_B
8	RS485_GND/CAN_GND
4	CAN_H
5	CAN_L



Ground wire assembly

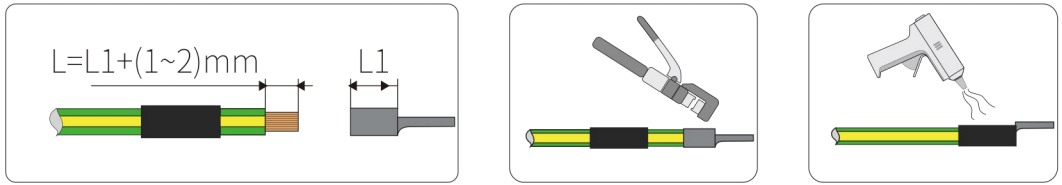

5.5.3.2 Harness Connection

**⚠ Caution**

Installation sequence of connecting wires: Ground wire assembly → Communication line assembly → Assemble the orange (positive) power line → Assemble the black (negative) power line. When installing the equipment, the protective ground wire must be installed first; when removing the equipment, the protective ground wire must be the last to be removed.

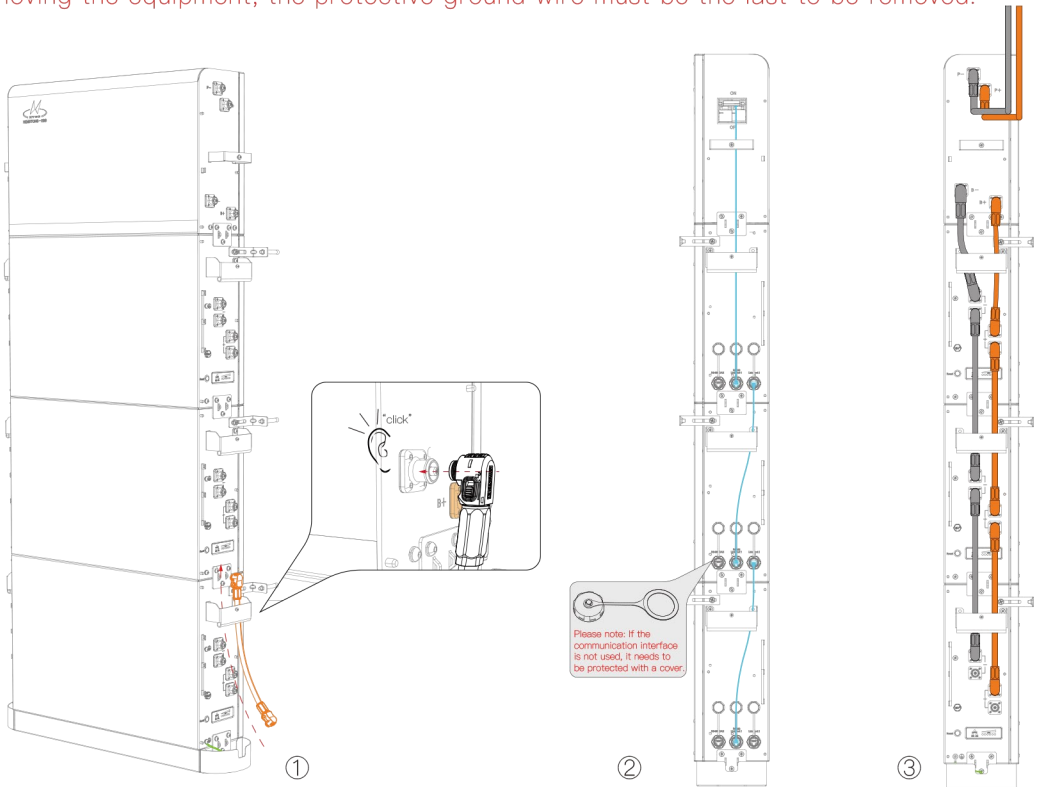

- ① First, connect the grounding wire.
- ② Thread the communication harness through the bottom end of the handle, and follow the diagram for the connection and insertion, and so on.
- ③ Assemble the power lines in the order of orange (positive) first, followed by black (negative).

### 5.5.3.3 System Boot-up.

After all wiring harness connections are completed (including the inverter end), turn on all battery packs

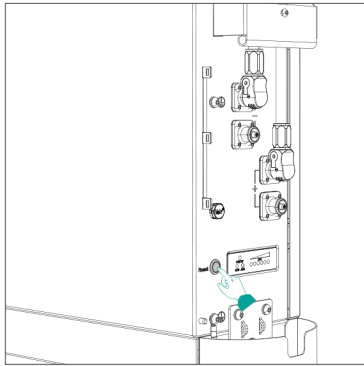

The green light on the "run" indicator illuminating signifies a successful startup.



### 5.5.3.4 Installation of decorative cover plates

① Closing of the electrical box air switch

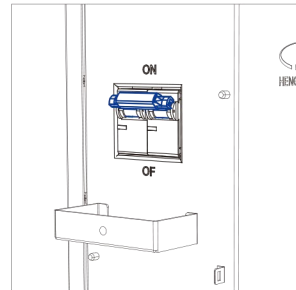
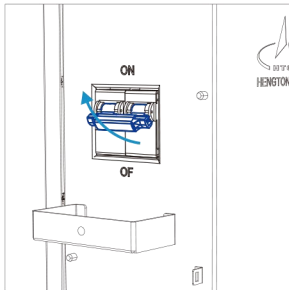

② Installation of decorative covers

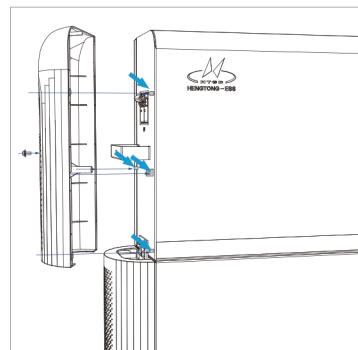
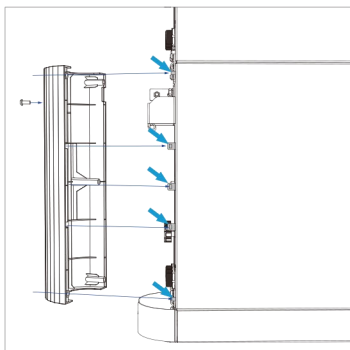

Installation of communication side decorative covers

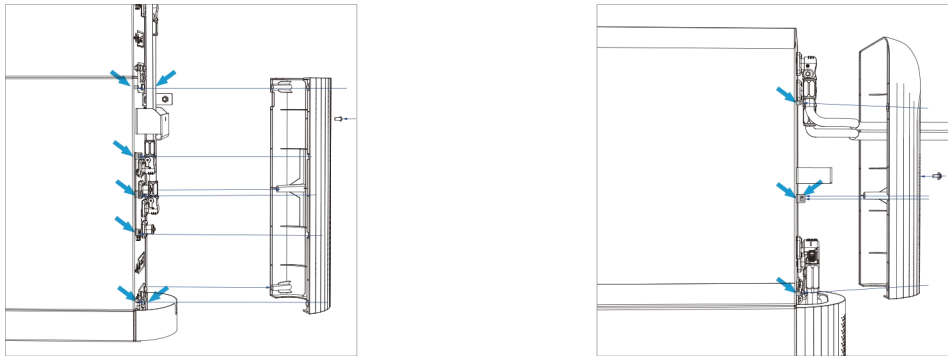

Installation of the power cord side decorative cover

#### 5.5.3.5 System shutdown

When shutting down the battery system, please follow the sequence of the following steps to prevent damage to the system:

Remove all decorative covers from the power cord side of the battery box

Press and hold the power button until all indicator lights go out.

## 6. MAINTENANCE GUIDE

### 6.1 Maintenance Cautions

(1) In order to perform system maintenance and upkeep safely and effectively, maintenance personnel must undergo professional training and be qualified for the job. When carrying out maintenance work, it is crucial to adhere to relevant safety precautions, use necessary tools, and wear protective equipment.

(2) Do not wear gold, silver jewelry, watches, and other metal accessories when operating and maintaining the system.

(3) Use insulated tools, wear insulated gloves, and insulated shoes during maintenance.

(4) After completing maintenance tasks, promptly clean up tools and materials. Do not place metal items and tool parts inside or on top of the equipment.

(5) When connecting or disconnecting system cables, ensure that all switches are in the off position, and pay attention to positive and negative pole protection.

(6) If system operators or maintenance personnel have any doubts about the operation and maintenance of the equipment, they should stop the operation and contact the manufacturer for consultation. Unauthorized operation is strictly prohibited.

⚠ Always remember that even when the battery cabinet is not operational, there is still a potentially dangerous voltage inside. After turning off all battery box air switches, ensure that the inverter and all DC and AC power sources are completely isolated for at least 5 minutes before using a voltmeter to check. Make sure all power sources are disconnected and in a safe state before performing maintenance work.

### 6.2 Periodic Maintenance

To maintain the efficiency and reliability of the energy storage system operation, please perform the following operations regularly:

(1) Maintain environmental cleanliness to prevent dust or chemical contamination on the battery cabinet.

(2) Regular (every 6 months) dust removal: Clean the system regularly. Before dust removal, the power must be disconnected, and washing with water is strictly prohibited.

(3) Regularly (every 6 months) inspect the wiring terminals of input and output cables. Carefully check for any looseness or foreign objects, examine if the terminal surfaces exhibit severe rust or oxidation, and measure the quality of the contacts.

- (4) Regularly (every 6 months) inspect whether the cables are aging or damaged and check the insulation for its integrity.
- (5) Regularly (every 6 months) check the operational status of the battery cabinet.
- (6) Waterproof board: Check if waterproof boards of components are replaced annually.

### 6.3 Diagnosis of Common Abnormalities

After activating the battery cabinet, if it cannot function properly, refrain from immediately determining it as a cabinet malfunction. Refer to Table 6–1 to identify potential causes. Also, check whether external environmental factors such as temperature, humidity, or load overload may be contributing to the issue.

If troubleshooting using the methods in Table 6–1 does not resolve the problem, seek assistance from professionals for repairs.

This chapter includes only some basic fault diagnosis procedures. If the diagnosis is unclear or the information obtained is insufficient to solve the problem, please contact HengTong Energy storage’s after-sales support for assistance.

NO	Fault Or Alarm Symptoms	Possible Causes Of The Fault	Troubleshooting Solutions
01	Wi-fi faults	a.Data stick damage	Replace the data stick
		b.Poor wire harness contact	Re-plug or replace
		a.Abnormal wire harness connection	Check wire harness connections
02	Battery, and pcs communication faults	b.BMS failure	Replace bms
		c.Damaged RJ45	Replace rj45
		d.PCS anomaly	
03	Overcurrent protection during charging	Excessive current discharge in the current system	Reduce power
04	Overcurrent protection during discharge	Excessive current charge in the current system	Reduce power
		a.Excessively high environmental temperature	Disallow discharge, lower environmental temperature
05	High-temperature protection during discharge	b.Abnormal temperature in a single cell	Abnormal temperature in a single cell
		c.Excessive charge/discharge current	Stop discharge
06	Low-temperature protection during discharge	Excessively low environmental temperature	Disallow discharge
		a.Excessively high environmental temperature	Disallow charging, decrease in environmental temperature.
07	High-temperature protection during charging	b.Abnormal temperature in a single cell	Stop charging
		c.Excessive charge/discharge current	Reduce charging current
08	Low-temperature protection during charging	Excessively low environmental temperature	Allow no charging
09	Total pressure low voltage protection	Excessively high total voltage	Stop charging
10	Overvoltage protection	Over-discharge of the battery	Stop discharge, charge immediately
11	High voltage protection for individual cells	Excessively high individual cell voltage	Stop charging
12	Low voltage protection for individual cells	Over-discharge of the battery	Stop discharge, charge immediately
13	Relay sticking	Relay damage	Replace the relay
14	Ntc abnormality	Damaged NTC	Replace NTC
15	Insulation monitoring	Battery pack leakage.	After tripping the circuit breaker, contact customer service.
		a.Abnormal wire harness connection	Check the wire harness connection
16	Internal communication abnormality in bms	b.BMS failure	Replace BMS
		c.Damaged RJ45	ReplaceRJ45

## 6.4 Battery Protection

Under the following conditions, the battery will limit the charge/discharge current for protective purposes:

- (1) Battery SOC is below 1-DOD (Depth of Discharge).
- (2) Battery overheating protection.
- (3) Lithium battery BMS restrictions.
- (4) Battery voltage is below the discharge voltage.
- (5) Communication abnormalities in the lithium battery.

When charge/discharge current limiting protection occurs:

- (1) In grid-connected mode, battery charge/discharge operations may be abnormal.
- (2) In off-grid mode, the off-grid power supply will be shut down.



### Caution

- (1) In off-grid mode, if the off-grid power supply is shut down due to low battery, battery SOC, or voltage, the energy generated by the photovoltaic side will be entirely used to charge the battery until the battery SOC reaches  $40\% + (1-DOD)/2$ , activating the off-grid power supply.
- (2) In both grid-connected and off-grid modes, the battery is protected against over-discharge based on DOD and discharge voltage.
- (3) Setting the battery DOD prevents the inverter from releasing the battery's backup power. Once the DOD set value is reached, the load will be powered only by the photovoltaic side or the grid. If the battery receives little or no charge for several consecutive days, the battery may continue to self-consume energy to maintain communication with the inverter. If the battery SOC reaches a certain level, the inverter will prompt an increase in SOC. This protective mechanism prevents the battery SOC from dropping to 0%.

## 6.5 Accident Handling

In the event of abnormalities or incidents in the system, timely and correct measures should be taken to address them, eliminating further damage and minimizing losses:

### (1) Overheating:

When the temperature of the battery pack exceeds the safe operating limit, the management system will issue a warning and immediately cease usage. In this case, usage should be stopped immediately, and relevant technical personnel should be notified for a comprehensive inspection. The system can only be resumed after the fault is rectified.

### (2) Leakage:

If a leakage is detected during system operation, personnel should be evacuated immediately. Notify relevant technical personnel to handle the situation, and usage can only continue after the fault is rectified. It is strictly forbidden to operate the system with faults or force it to continue.

### (3) Short Circuit:

In the event of a short circuit caused by various reasons, relevant personnel must be evacuated immediately. Cut off relevant power sources and electrical equipment (if possible), disconnect the battery from the system immediately, and notify technical personnel for on-site repairs. Devices and components severely affected by the short circuit must undergo comprehensive testing by the manufacturer before deciding whether they can continue to be used.

### (4) Collision:

If equipment is impacted, deformed, or pierced by foreign objects for any reason, disconnect the power connection line of the system immediately. Notify professional technicians to handle the situation. If the situation is special, personnel wearing necessary protective equipment can handle it on-site before dismantling work can proceed.

### (5) Other Incidents:

In the case of other incidents requiring maintenance or the removal of equipment or components, disconnect the battery circuit first to ensure personnel safety. Dismantle the components, ensuring no risk of short circuits, collisions, falls, inversions, or other secondary damage during the process.

## **Danger**

- (1) If you identify any issues that may affect the battery or energy storage inverter system, please contact the after-sales personnel. Unauthorized disassembly is strictly prohibited.
- (2) If you discover exposed copper wires inside a conductive cable, do not touch it as it poses a high voltage risk. Contact after-sales personnel immediately and refrain from unauthorized disassembly.
- (3) In the event of other emergencies, promptly contact after-sales personnel. Follow their guidance for operation or wait for on-site assistance from the after-sales team.

## 7. After-sales

Jiangsu Hengtong Energy Storage Co., Ltd. provides comprehensive technical support and after-sales service to its customers.

The free warranty service period is in accordance with the terms specified in the contract.

The following situations are not covered by our company's free warranty service:

- (1) System damage or faults caused by not following the operation instructions in the user manual.
- (2) Damage or faults caused by improper wiring, power supply according to relevant electrical safety specifications, or adverse on-site environmental conditions.
- (3) System damage or faults caused by unauthorized modifications by the user.
- (4) System damage or faults caused by irresistible natural factors such as typhoons, earthquakes, floods, fires, or harsh environmental conditions (high temperature, low temperature, high humidity, acid rain, etc.).
- (5) If the user fails to maintain the initial fault condition, does not promptly notify the manufacturer after a fault occurs, and handles the issue independently, making it impossible to provide a practical fault diagnosis.



Group Company

Hengtong Group Co., Ltd.

2288 Zhongshan North Road, Wujiang District, Suzhou City, Jiangsu Province, China

Energy Storage Company

Jiangsu Hengtong Energy Storage Technology Co., Ltd.

88 Hengtong Road, Wujiang District, Suzhou City, Jiangsu Province, China

☎ 0512-63951158

🌐 WWW.HTGD.COM.CN

🌐 WWW.JSHTES.COM

